

REV	ECN NO	DESCRIPTION	DATE	NAME
A	—	NEW	11/22-'19	HYJ

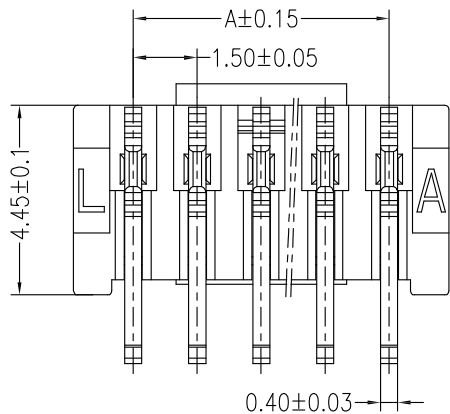

0.1

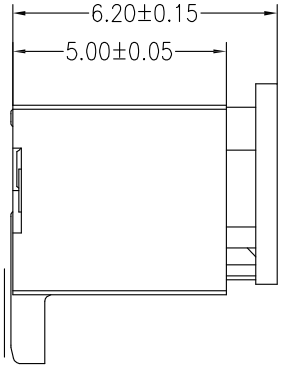

PCB LAYOUT

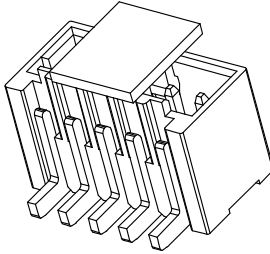
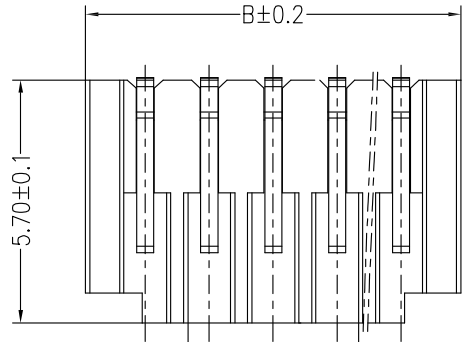
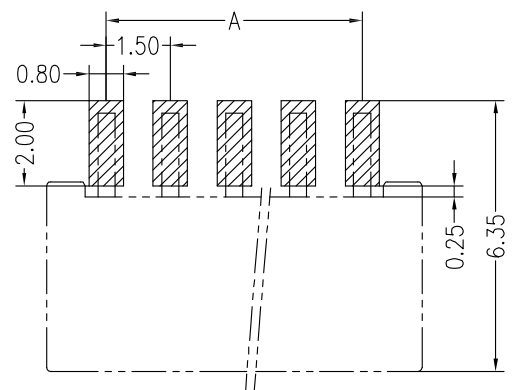

Main Specifications

- Poles : 02 to 15
- Contact resistance : $\leq 20m\Omega$
- Insulation resistance : $\geq 1000M\Omega$
- Rated voltage : 350V AC DC
- Rated current : 3.0A AC DC
- Withstand Voltage : 500V AC/minute
- Temperature Range : -25°C ~ +85°C

ORDER INFORMATION:

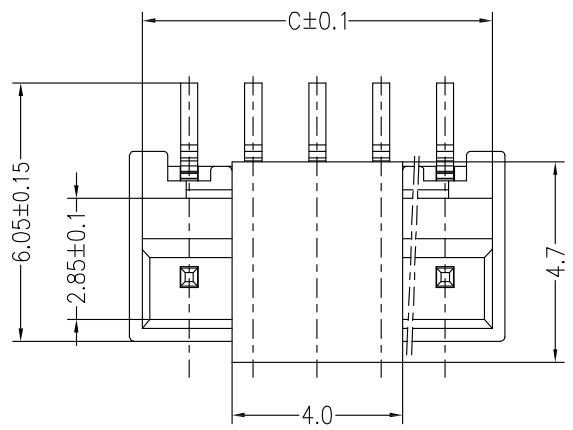
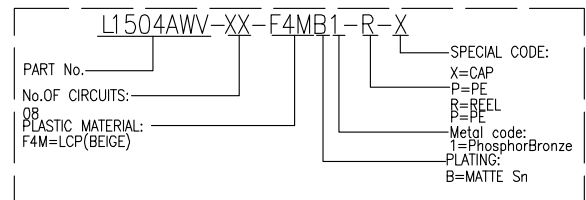

PIN	DIM A	DIM B	DIM C
2pin	1.50	4.30	3.70
3pin	3.00	5.80	5.20
4pin	4.50	7.30	6.70
5pin	6.00	8.80	8.20
6pin	7.50	10.30	9.70
7pin	9.00	11.80	11.20
8pin	10.50	13.30	12.70
9pin	12.00	14.80	14.20
10pin	13.50	16.30	15.70
11pin	15.00	17.80	17.20
12pin	16.50	19.30	18.70
13pin	18.00	20.80	20.20
14pin	19.50	22.30	21.70
15pin	21.00	23.80	23.20

TOLERANCE UNLESS OTHERWISE SPECIFIED

LINER	ANGLES
.0 ±0.30	0.° ±3°
.00 ±0.20	.0° ±2°
.000 ±0.10	.00° ±1°

C	CAP	1 PCS	LCP	UL 94V-0, COLOR:BEIGE
B	CONTACT	2~15 PCS	PhosphorBronze	MATTE Sn-plated
A	HOUSING	1 PCS	LCP	UL 94V-0, COLOR:BEIGE
ITEM	COMPONENT	Q'TY	MATERIAL	FINISH

LDCONN 东莞连大精密制品有限公司
 DongGuan LianDa Precision Products Co., LTD

TITLE	1.5mmPITCH 90°WAFER SMT TYPE	DRAWN BY	HYJ	11/22-'19
PART NO.	L1504AWV-XX-F4MB1-R-X	CHECKED BY		
DRAWING NO.		APPROVED BY		
SCALE	1:1	UNIT	mm	PAGE 1/1
				SIZE A4