

■ **Specifications**

- Contact resistance: $\leq 20\text{m}\Omega$
- Insulation resistance: $\geq 1000\text{M}\Omega$
- Rated voltage: 250V AC DC
- Rated current: 3.0A AC DC
- Withstand voltage: 800V AC/minute
- Temperature range: $-40^{\circ}\text{C} \sim +105^{\circ}\text{C}$

■ **Assembly Layout**

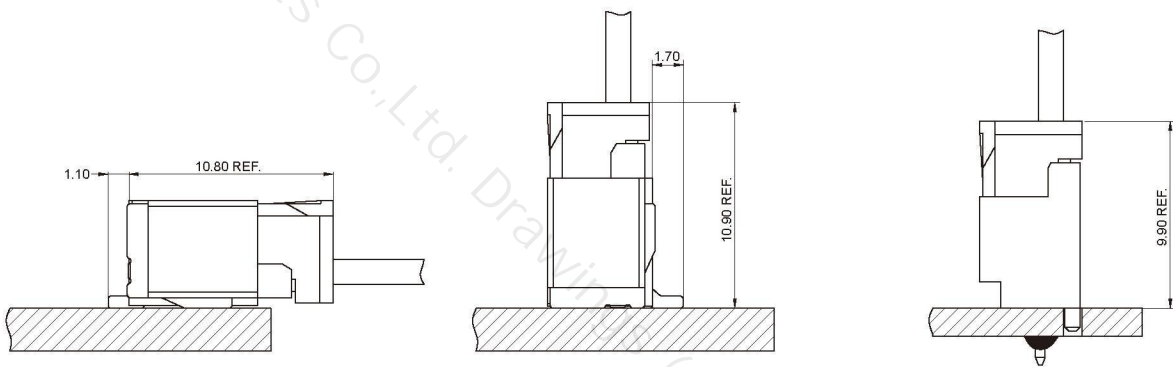

WIRE TO BOARD

BOARD TO BOARD

WIRE TO WIRE

FPC SERIES

THR SERIES

LIGHTING SERIES

OTHER SERIES

A2008AWR (2.00mm pitch 90°Wafer SMT TYPE)

- Reference Information:
- Material: Pin: Brass/Tin-plated
- Solder Tabs: Brass/Tin-plated
- Wafer: PA6T/LCP,UL94V-0
- Mates with A2008 series Housing

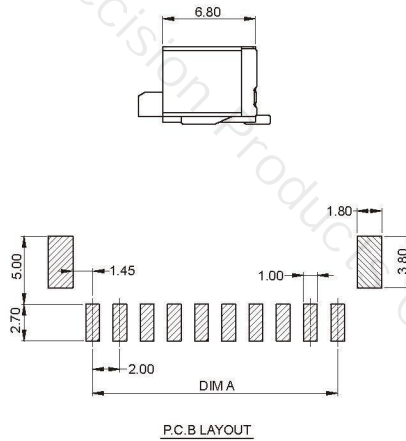
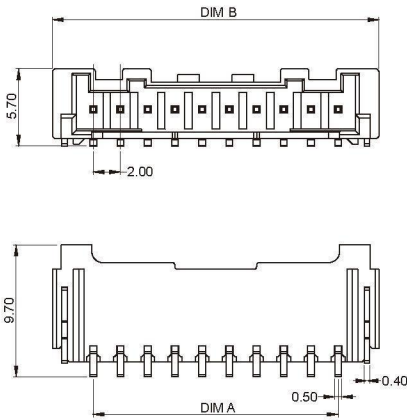
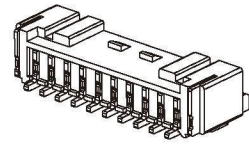

Ordering Information & Dimensions:

Circuit	Dimensions(mm)	
	A	B
02	2.00	8.30
03	4.00	10.30
04	6.00	12.30
05	8.00	14.30
06	10.00	16.30
07	12.00	18.30
08	14.00	20.30
09	16.00	22.00
10	18.00	24.00
11	20.00	26.00
12	22.00	28.00
13	24.00	30.00
14	26.00	32.00
15	28.00	34.00

A2008AWV (2.00mm pitch 180°Wafer SMT TYPE)

- Reference Information:
- Material: Pin: Brass/Tin-plated
- Solder Tabs: Brass/Tin-plated
- Wafer: PA6T/LCP,UL94V-0
- Mates with A2008 series Housing

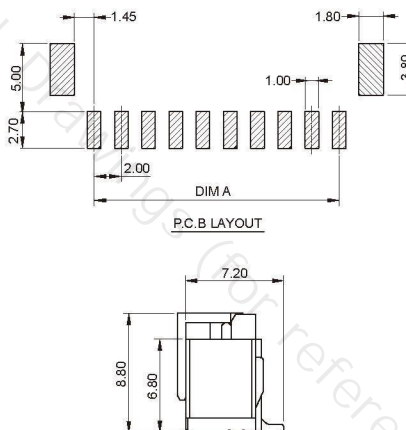
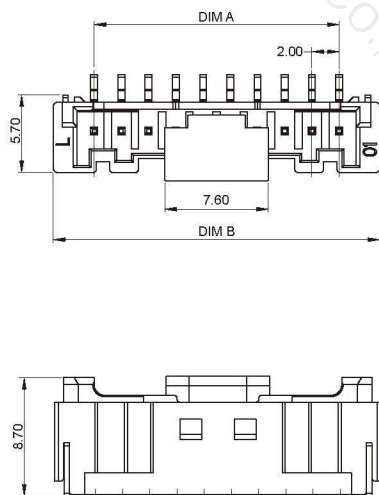
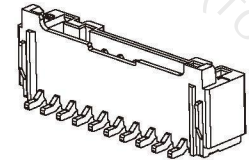

Ordering Information & Dimensions:

Circuit	Dimensions(mm)	
	A	B
02	2.00	8.30
03	4.00	10.30
04	6.00	12.30
05	8.00	14.30
06	10.00	16.30
07	12.00	18.30
08	14.00	20.30
09	16.00	22.00
10	18.00	24.00
11	20.00	26.00
12	22.00	28.00
13	24.00	30.00
14	26.00	32.00
15	28.00	34.00

A2008A (2.00mm pitch 180°Wafer DIP TYPE)

- Reference Information:
- Material: Pin: Brass/Tin-plated
- Wafer: PA66,UL94V-0
- Mates with A2008 series Housing

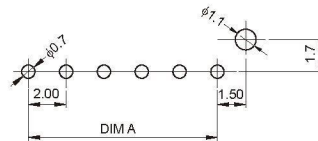
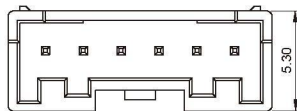
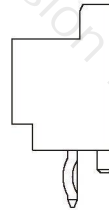
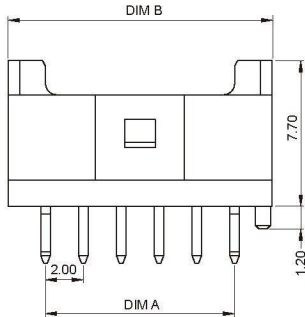
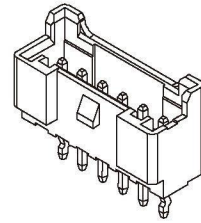

Ordering Information & Dimensions:

Circuit	Dimensions(mm)	
	A	B
02	2.00	6.00
03	4.00	8.00
04	6.00	10.00
05	8.00	12.00
06	10.00	14.00
07	12.00	16.00
08	14.00	18.00
09	16.00	20.00
10	18.00	22.00
11	20.00	24.00
12	22.00	26.00
13	24.00	28.00
14	26.00	30.00
15	28.00	32.00

A2008Y (2.00mm pitch Housing)

- Reference Information:
- Material: PA66,UL94V-0(2)
- Suitable A2003 series terminal
- Mates with A2008 series Wafer

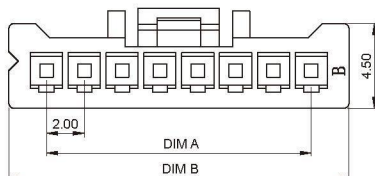
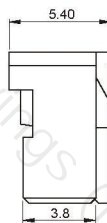
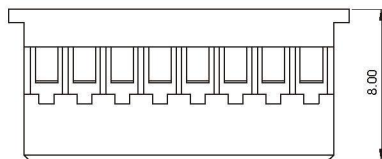
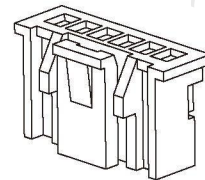

Ordering Information & Dimensions:

Circuit	Dimensions(mm)	
	A	B
02	2.00	6.00
03	4.00	8.00
04	6.00	10.00
05	8.00	12.00
06	10.00	14.00
07	12.00	16.00
08	14.00	18.00
09	16.00	20.00
10	18.00	22.00
11	20.00	24.00
12	22.00	26.00
13	24.00	28.00
14	26.00	30.00
15	28.00	32.00