

NOTES:

MATERIAL:

- 1. HOUSING: THERMO-PLASTIC. UL 94V-0 NATURE
 - 2. CONTACT: COPPER ALLOY
- CONTACT: SEE ORDER INFORMATION;
SOLDER: 10u" GOLD IN CONTACT AREA, MATTE TIN ON TAIL

ELECTRICAL:

- 1. CURRENT RATING: 60 A MAX
- 2. WITHSTANDING VOLTAGE: 600V AC for 1 min
- 3. INSULATION RESISTANCE: 1000MΩ MIN

ENVIRONMENTAL:

- 1. OPERATING TEMPERATURE: -55°C TO +125°C.

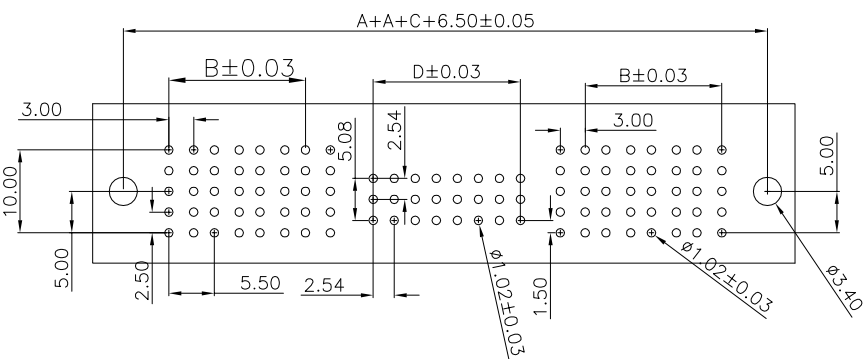
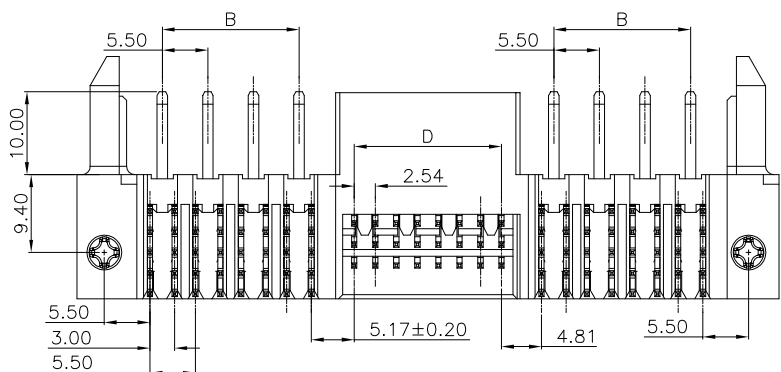
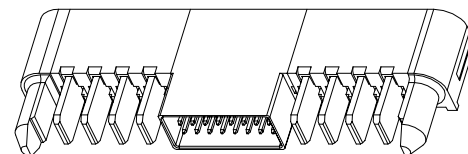

Recommended PC board pattern
(TOP VIEW)

| TAIL | E | F |
|------|------|------|
| 1 | 2.84 | 2.84 |
| 2 | 3.61 | 3.41 |

| SIGNAL | C | D |
|--------|-------|-------|
| 06 | 8.02 | 2.54 |
| 12 | 13.10 | 7.62 |
| 18 | 18.18 | 12.70 |
| 24 | 23.26 | 17.78 |
| 30 | 28.34 | 22.86 |
| 36 | 33.42 | 27.94 |

| POWER | A | B |
|-------|-------|-------|
| 01 | 7.50 | N/A |
| 02 | 13.00 | 5.50 |
| 03 | 18.50 | 11.00 |
| 04 | 24.00 | 16.50 |
| 05 | 29.50 | 22.00 |
| 06 | 35.00 | 27.50 |
| 07 | 40.50 | 33.00 |
| 08 | 46.00 | 38.50 |
| 09 | 51.50 | 44.00 |
| 10 | 57.00 | 49.50 |

RoHS Compliant
2013/05/EC



| | | |
|---------------------------|---------------------|--|
| 一般公差 GENERAL TOLERANCE | Jerry 2020.01.15 | 品名(TITLE): ET60T BENDING TYPE PLUG |
| .I ±0.35 | 制图(DR): | 料号(PART NO): L60TB15*-*****-BOT |
| .II ±0.25 | 审核(CHEK): | 比例(SCALE) 单位(UNITS) 张数(SHEET) 图幅(SIZE) |
| .III ±0.10 | Tong 2020.01.15 | 1:1 mm 1 OF 1 A4 |
| ANGLES ±1° | 核准(APPD): | |

| 修订 SER | 修改摘要 REVISION DESCRIPTION | 签名 SIGNATURE | 日期 DATE |
|-----------|------------------------------|-----------------|------------|
| | | | |



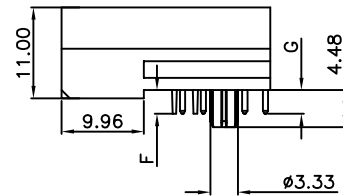
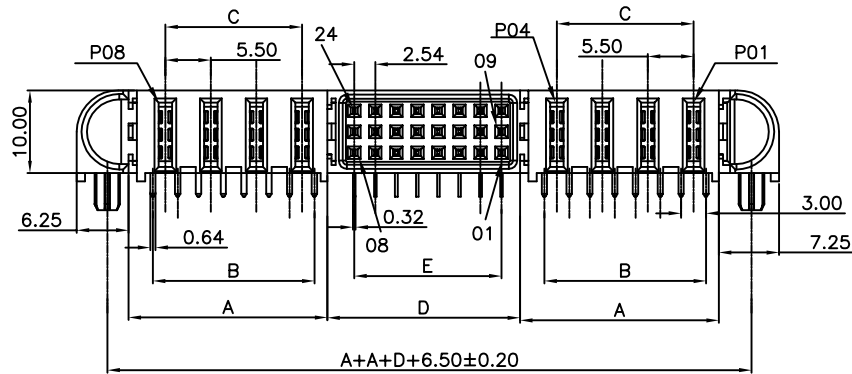

NOTES:
 MATERIAL:
 1.HOUSING:THERMO-PLASTIC. UL 94V-0 NATURE
 2.CONTACT:COPPER ALLOY
 CONTACT:SEE ORDER INF ORMATION;
 SOLDER:10u" GOLD IN CONTACT AREA, MATTE TIN ON TAIL

ELECTRICAL:
 1.CURRENT RATING:60 A MAX
 2.WITHSTANDING VOLTAGE:600V AC for 1 min
 3.INSULATION RESISTANCE:1000MΩ MIN

ENVIRONMENTAL:
 1. OPERATING TEMPERATURE:-55°C TO +125°C.

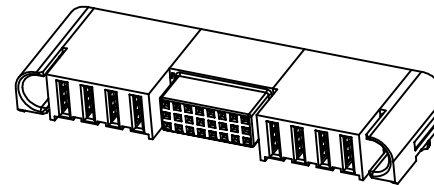

| TAIL | F | G |
|------|------|------|
| 1 | 2.84 | 2.84 |
| 2 | 3.61 | 3.41 |

| SIGNAL | D | E |
|--------|-------|-------|
| 06 | 8.02 | 2.54 |
| 12 | 13.10 | 7.62 |
| 18 | 18.18 | 12.70 |
| 24 | 23.26 | 17.78 |
| 30 | 28.34 | 22.86 |
| 36 | 33.42 | 27.94 |

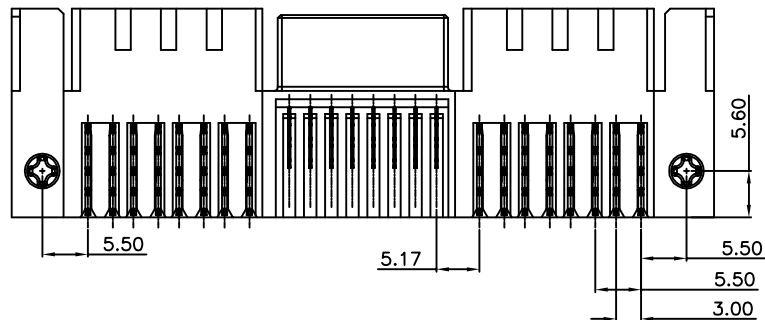

| POWER | A | B | C |
|-------|-------|-------|-------|
| 01 | 7.50 | N/A | N/A |
| 02 | 13.00 | 8.50 | 5.50 |
| 03 | 18.50 | 14.00 | 11.00 |
| 04 | 24.00 | 19.50 | 16.50 |
| 05 | 29.50 | 25.00 | 22.00 |
| 06 | 35.00 | 30.50 | 27.50 |
| 07 | 40.50 | 36.00 | 33.00 |
| 08 | 46.00 | 41.50 | 38.50 |
| 09 | 51.50 | 47.00 | 44.00 |
| 10 | 57.00 | 52.50 | 49.50 |

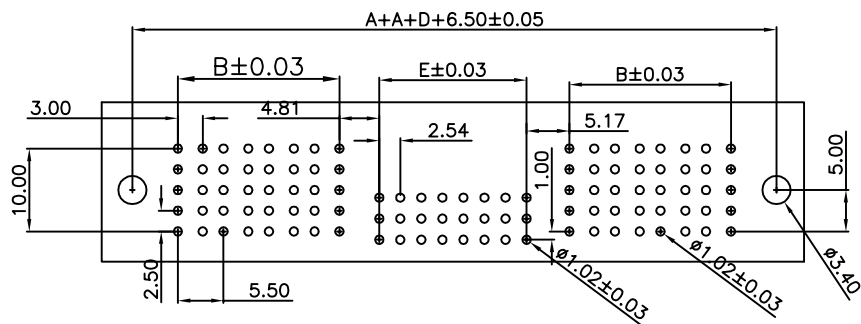

Recommended PC board pattern
(TOP VIEW)

| 修订 SER | 修改摘要 REVISION DESCRIPTION | 签名 SIGNATURE | 日期 DATE |
|-----------|------------------------------|-----------------|------------|
| | | | |

| 一般公差 GENERAL TOLERANCE | |
|---------------------------|-------|
| .X | ±0.35 |
| .XX | ±0.25 |
| .XXX | ±0.10 |
| ANGLES | ±1° |

| | |
|-----------|---------------------|
| 制图 (DR): | Jerry 2020.01.15 |
| 审核 (CHD): | Tong 2020.01.15 |

| | | | | | |
|--------------|---------------------------|------------|----|------------|--------|
| 品名(TITLE): | ET60S BENDING TYPE SOCKET | | | | |
| 料号(PART NO): | L60SB15*-***-BOT | | | | |
| 比例(SCALE): | 1:1 | 单位(UNITS): | mm | 张数(SHEET): | 1 OF 1 |
| 核准 (APPD): | | 图幅(SIZE): | A4 | | |



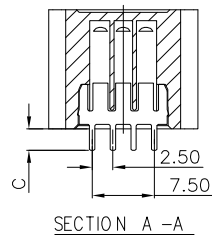
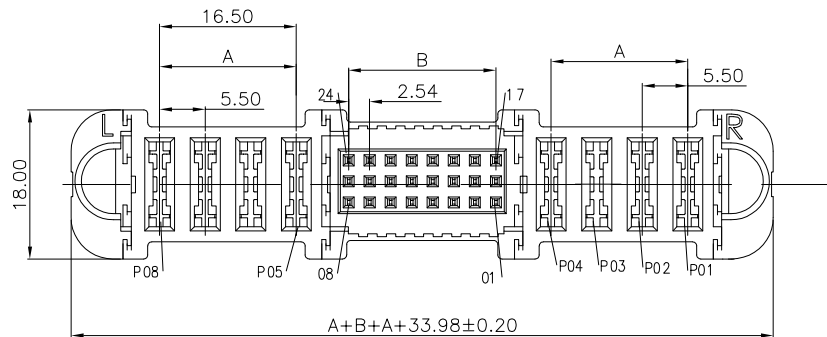

NOTES:

MATERIAL:

- 1.HOUSING:THERMO-PLASTIC. UL 94V-0 NATURE
- 2.CONTACT:COPPER ALLOY
- CONTACT:SEE ORDER INF ORMATION;
- SOLDER:10u" GOLD IN CONTACT AREA, MATTE TIN ON TAIL

ELECTRICAL:

- 1.CURRENT RATING:60 A MAX
- 2.WITHSTANDING VOLTAGE:600V AC for 1 min
- 3.INSULATION RESISTANCE:1000MΩ MIN

ENVIRONMENTAL:

- 1. OPERATING TEMPERATURE:-55°C TO +125°C.

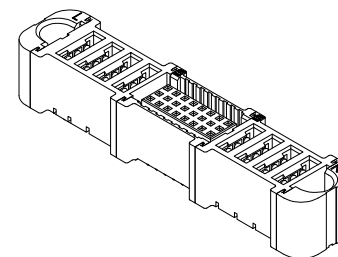
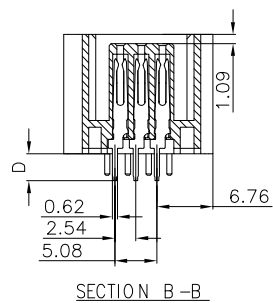
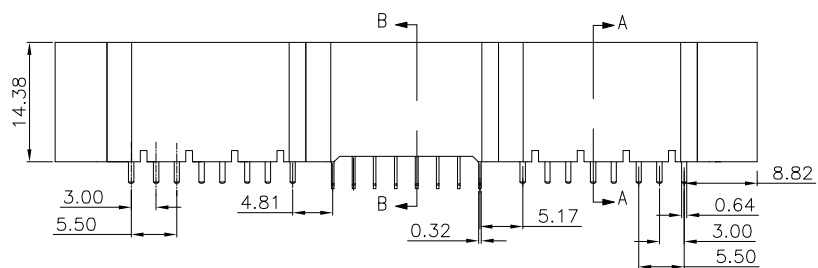

| TAIL | C | D |
|------|------|------|
| 1 | 2.60 | 3.28 |
| 2 | 2.83 | 3.28 |

| SIGNAL | B |
|--------|-------|
| 06 | 2.54 |
| 12 | 7.62 |
| 18 | 12.70 |
| 24 | 17.78 |
| 30 | 22.86 |
| 36 | 27.94 |

| POWER | A |
|-------|-------|
| 01 | N/A |
| 02 | 5.50 |
| 03 | 11.00 |
| 04 | 16.50 |
| 05 | 22.00 |
| 06 | 27.50 |
| 07 | 33.00 |
| 08 | 38.50 |
| 09 | 44.00 |
| 10 | 49.50 |

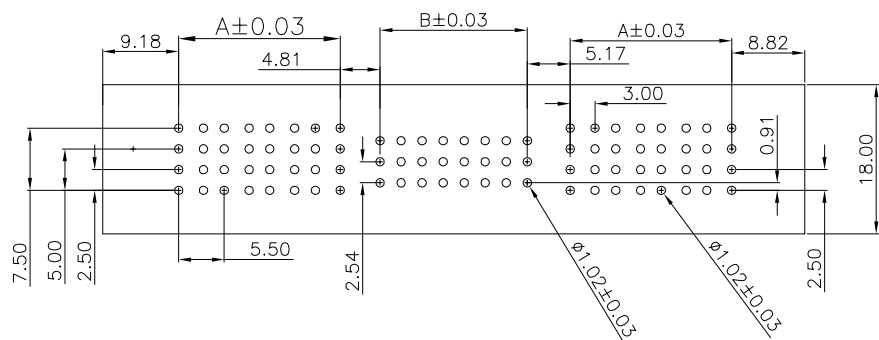

Recommended PC board pattern
(TOP VIEW)

RoHS Compliant
2013/05/EC



| | | | | | | | | | | | | | | | |
|--------------|--|-----------------------------|--|--|--|-------------------------------|--|---------------------------------------|--|--------------|--|------------------|--|-------------|--|
| | | | | 一般公差 GENERAL TOLERANCE .X ±0.35 .XX ±0.25 .XXX ±0.10 ANGLES ±1° | | 制图 (DR): Jerry 2020.01.15 | | 品名(TITLE): ET60S STRAIGHT TYPE SOCKET | | | | | | | |
| | | | | 版本 (REV) A | | 审核 (CHKD): Tong 2020.01.15 | | 料号(PART NO): L60SS15*-*****-B0T | | | | | | | |
| 修订 (REV) SER | | 修改摘要 (REVISION DESCRIPTION) | | 签名 (SIGNATURE) | | 日期 (DATE) | | 比例(SCALE) 1:1 | | 单位(UNITS) mm | | 张数(SHEET) 1 OF 1 | | 图幅(SIZE) A4 | |